

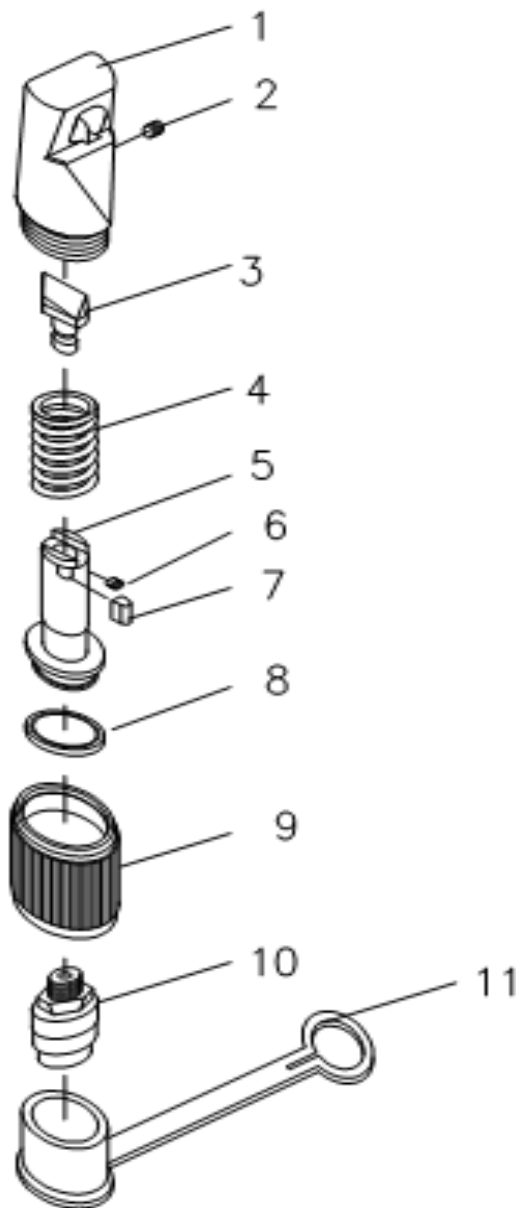

EAGLE PRO Nut Splitters should be repaired only by a qualified operator or Authorized EAGLE PRO Service Centers. Use Only EAGLE PRO or other approved hydraulic oil. Release pressure in hydraulic system and disconnect hose(s) before making repair.

Parts List



Item No.	Part Number	Description	Quantity
1	ENS003-1	Nut Adapter Block	1
2	ENS003-2	Screw	1
3	ENSB-003	Blade	1
4	ENS003-4	Spring	1
5	ENS003-5	Piston	1
6	ENS003-6	Screw	1
7	ENS003-7	Bond	1
8★	ENS003-8	Y-ring	1
9	ENS003-9	Cylinder	1
10	EAB-201A	Coupler	1
11	EABC-201	Cover	1

★ Items included in Repair Kit, Repair Kit order number: **ENS003-RP-0**