

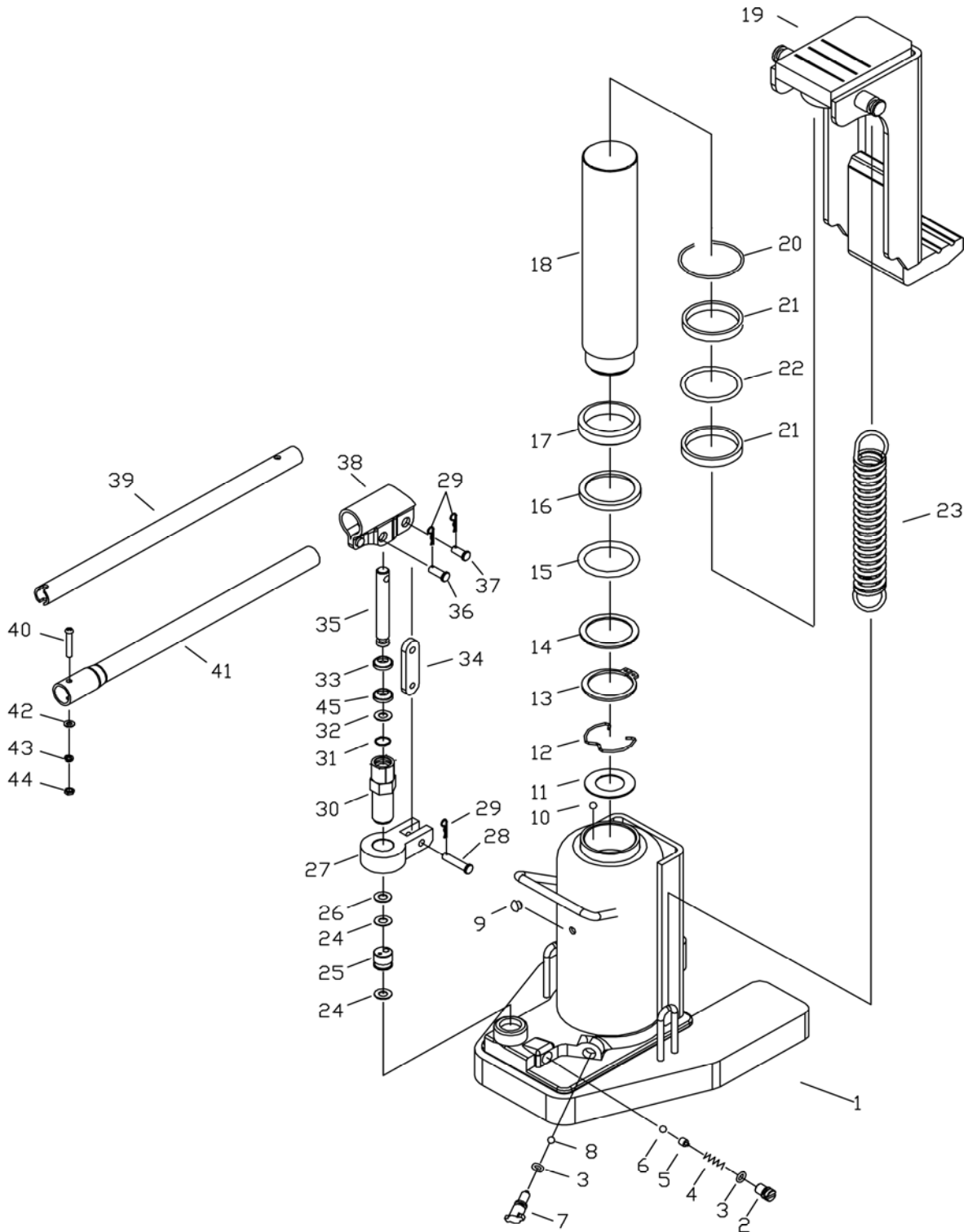

EAGLE PRO Jacks should be repaired only by a qualified operator or Authorized EAGLE PRO Service Centers. Use Only EAGLE PRO or other approved hydraulic oil. Release pressure in hydraulic system and disconnect hose(s) before making repair.

Parts List



Item No.	Part Number	Description	Quantity	Item No.	Part Number	Description	Quantity
1	ETJ110-1	Pump Unit	1	24★	ETJ110-24	Copper Washer	2
2	ETJ110-2	Bolt	1	25	ETJ110-25	Oil Valve	1
3★	ETJ110-3	O-ring	2	26	ETJ110-26	Nylon Snap Ring	1
4	ETJ110-4	Spring	1	27	ETJ110-27	Pump Base	1
5	ETJ110-5	Sealing Washer	1	28	ETJ110-28	Link Rod Pin	1
6	ETJ110-6	Steel Ball	1	29	ETJ110-29	Pin	3
7	ETJ110-7	Release Valve Rod	1	30	ETJ110-30	Pump Cylinder	1
8	ETJ110-8	Steel Ball	1	31★	ETJ110-31	O-ring	1
9	ETJ110-9	Oil Filler Plug	1	32	ETJ110-32	Nylon Snap Ring	1
10	ETJ110-10	Steel Ball	2	33★	ETJ110-33	Wiper Ring	1
11	ETJ110-11	Washer	1	34	ETJ110-34	Link Rod	1
12	ETJ110-12	Snap Ring	1	35	ETJ110-35	Cylinder Pump Plunger	1
13	ETJ110-13	Snap Ring	1	36	ETJ110-36	Pin	1
14	ETJ110-14	Snap Ring	1	37	ETJ110-37	Link Rod Pin	1
15★	ETJ110-15	O-ring	1	38	ETJ110-38	Handle Socket	1
16	ETJ110-16	Washer	1	39	ETJ110-39	Handle	1
17	ETJ110-17	Washer	1	40	ETJ110-40	Bolt	1
18	ETJ110-18	Ram	1	41	ETJ110-41	Handle	1
19	ETJ110-19	Hanger	1	42	ETJ110-42	Washer	1
20	ETJ110-20	Snap Ring	1	43	ETJ110-43	Lock Washer	1
21	ETJ110-21	Snap Ring	2	44	ETJ110-44	Bolt	1
22★	ETJ110-22	O-ring	1	45	ETJ110-45	Seal	1
23	ETJ110-23	Spring	2				

★ Items included in Repair Kit, Repair Kit order number: **ETJ110-RP-0**